



Features

- Single device for two I/O lines
- Low capacitance for high-speed CANbus
- IEC 61000-4-2 30 kV ESD
- IEC 61000-4-5 (Level 1, CWG 1.2/50) 500 V Surge
- RoHS compliant*

Applications

- High-speed CANbus
- Industrial control networks
- Smart Distribution Systems (SDS)
- DeviceNet™
- Factory and process automation systems
- Lift control systems

CDSOT23-T24CAN CANbus Protector

General Information

The Model CDSOT23-T24CAN device is designed to provide ESD and surge protection for CAN transceivers, meeting IEC 61000-4-2 (ESD) and IEC 61000-4-5 (Surge) requirements. The dual TVS array protects both data lines, offers a Working Reverse Voltage of 24 V and a Minimum Breakdown Voltage of 26.2 V and can be used with transceivers with internal circuitry for 24 V power supply miswiring. The low capacitance and low leakage current of the Model CDSOT23-T24CAN minimizes impact on signal integrity and is compatible with high-speed CAN.

The SOT-23 packaged device conforms to JEDEC standards and will mount directly onto the industry standard SOT-23 footprint. Its compact size eases layout on compact PCB designs while ensuring compliance with stringent EMI requirements.

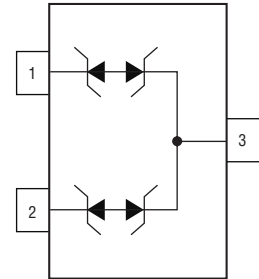

Absolute Maximum Ratings (@ T_A = 25 °C Unless Otherwise Noted)

Rating	Symbol	Value	Unit
Repetitive Peak Off-state Voltage	V _{DRM}	24	V
Non-Repetitive Peak Impulse Current, 8/20 μs Waveform	I _{PPSM}	8	A
Non-Repetitive Peak Impulse Current, 1.2/50 μs Waveform	I _{PPSM}	6	A
ESD (IEC 61000-4-2 Contact)		30	kV
Junction Temperature	T _J	-40 to +150	°C
Storage Temperature	T _{stg}	-55 to +150	°C

Electrical Characteristics (@ T_A = 25 °C Unless Otherwise Noted)

Parameter		Test Condition	Min.	Typ.	Max.	Unit
I _D	Leakage Current	V _D = V _{DRM}			100	nA
V _{BR}	Breakdown Voltage	I _{BR} = 1 mA	26.2		32	V
V _C	Clamping Voltage	I = 5 A 8/20 μs waveform		36		V
V _C	Clamping voltage	I = 8 A 8/20 μs waveform		40		V
C	Capacitance	V _D = 0 V, f = 1 MHz V _{osc} = 1 Vrms	Line to GND (Pin 1-3 or Pin 2-3)	22	30	pF
			Line to Line (Pin 1-2)	11		

BOURNS®

Asia-Pacific: Tel: +886-2 2562-4117 • Email: asiacus@bourns.com

EMEA: Tel: +36 88 520 390 • Email: eurocus@bourns.com

The Americas: Tel: +1-951 781-5500 • Email: americus@bourns.com

www.bourns.com

DeviceNet™ is a trademark of ODVA.

*RoHS Directive 2002/95/EC Jan. 27, 2003 including annex and RoHS Recast 2011/65/EU June 8, 2011.

Specifications are subject to change without notice.

The device characteristics and parameters in this data sheet can and do vary in different applications and actual device performance may vary over time. Users should verify actual device performance in their specific applications.

Rating & Characteristic Curves

8/20 μ s Pulse Waveform

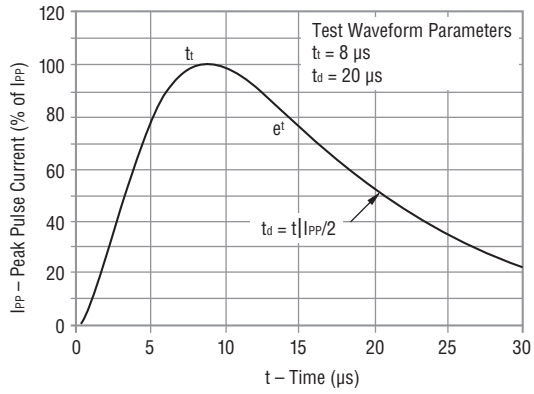

Clamping Voltage vs. Peak Pulse Current

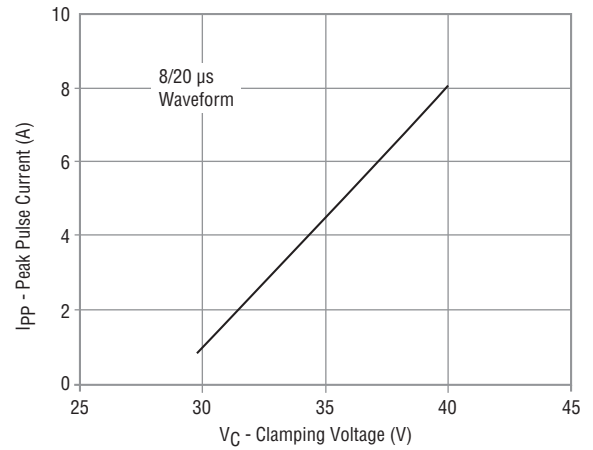

Leakage Current vs. Temperature

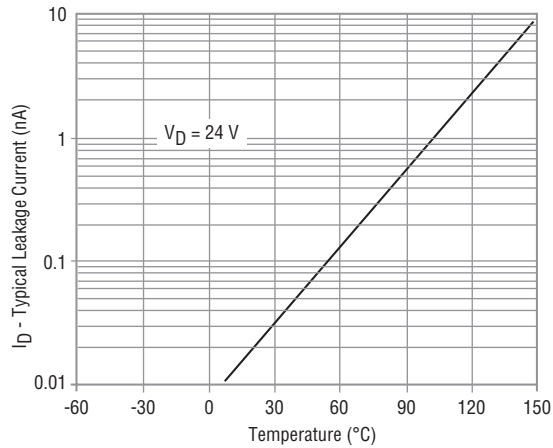

Breakdown Voltage vs. Temperature

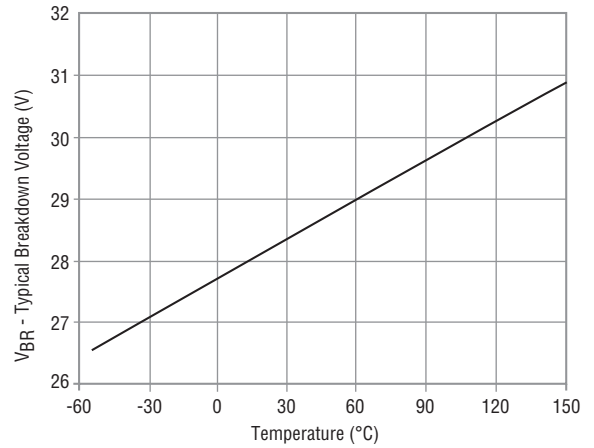

Specifications are subject to change without notice.
 The device characteristics and parameters in this data sheet can and do vary in different applications and actual device performance may vary over time.
 Users should verify actual device performance in their specific applications.

CDSOT23-T24CAN CANbus Protector

BOURNS®

Application Information

The Model CDSOT23-T24CAN dual TVS diode array is designed to protect a CANbus transceiver against surge events per IEC 61000-4-5 (Level 1), and also increase the resistibility against ESD events beyond IEC 61000-4-2 to as high as 30 kV. It is intended to be used with a transceiver that has internal protection against other faults such as 24 V power supply miswiring. The Model CDSOT23-T24CAN is designed with a minimum breakdown voltage of 26.2 V so that it will not conduct during a 24 VDC power cross event.

The surge test setup below shows the differential input/output (I/O) of a typical transceiver, its termination network, being protected by the CDSOT23-T24CAN device. The 1.2/50 μ s voltage, 8/20 μ s current combination wave generator is connected to the circuit through two 80 ohm resistors and a coupling device (CD). This circuit was subjected to a 500 V (1.2/50) longitudinal surge (common mode) in both positive and negative polarities per IEC 61000-4-5 (Level 1). The oscilloscope traces in Figures 1 and 2 show the clamp voltage with respect to ground for the CAN H and CAN L signal lines, as well as the total surge current output from the surge generator into the circuit, for each of these surges. The peak current on each line is ~ 5.5 A (11 A total/2 lines) when subjected to the 500 V (1.2/50) surge. The TVS diode clamps the voltage at the I/O of the transceiver within 37 V during the surge.

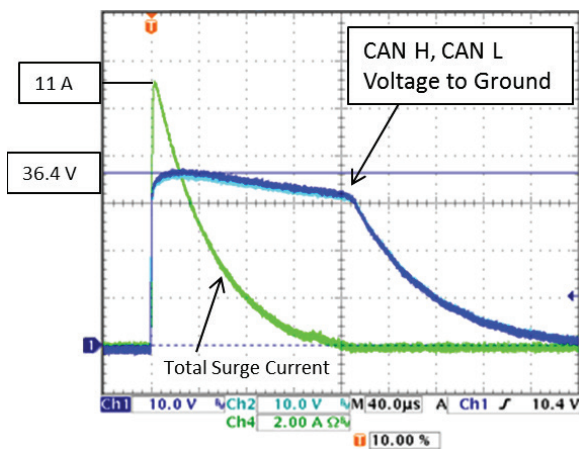
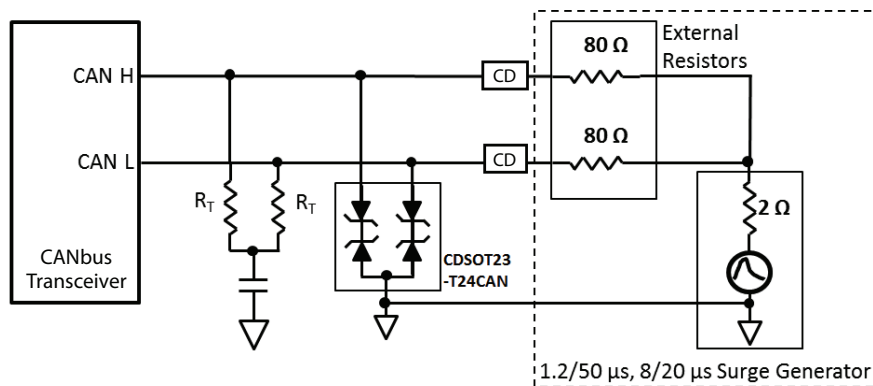

Figure 1 - CDSOT23-T24CAN Clamp Voltages for a +500 V Surge

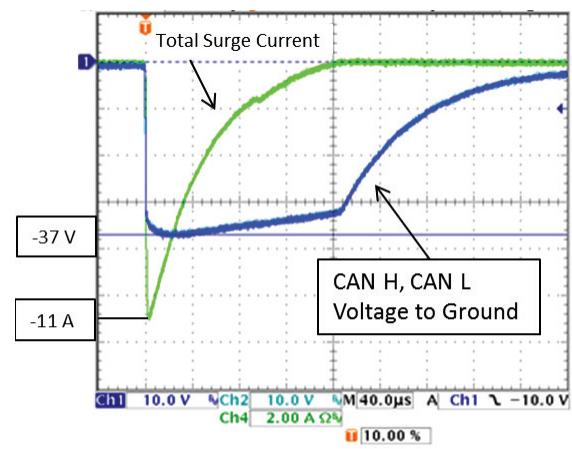

Figure 2 - CDSOT23-T24CAN Clamp Voltages for a -500 V Surge

Specifications are subject to change without notice. The device characteristics and parameters in this data sheet can and do vary in different applications and actual device performance may vary over time. Users should verify actual device performance in their specific applications.

CDSOT23-T24CAN CANbus Protector

BOURNS®

Layout Considerations

The figure below shows an example of how the Model CDSOT23-T24CAN can be connected on a two-sided PCB design. The device should be placed as close to the bus connector as possible with short traces to the signal lines. Since the connector pin spacing is generally much larger than the pin spacing of the transceiver, it is relatively easy to do this. A standard 10 mil, 1 ounce copper trace is more than adequate to handle the peak current level from the 500 V surge discussed in the previous section. The ground pin of the device should be connected to the circuit board ground plane using a short trace and a via. If there is a ground plane on the signal side of the circuit board near where the diode array is placed, it should be connected directly to it.

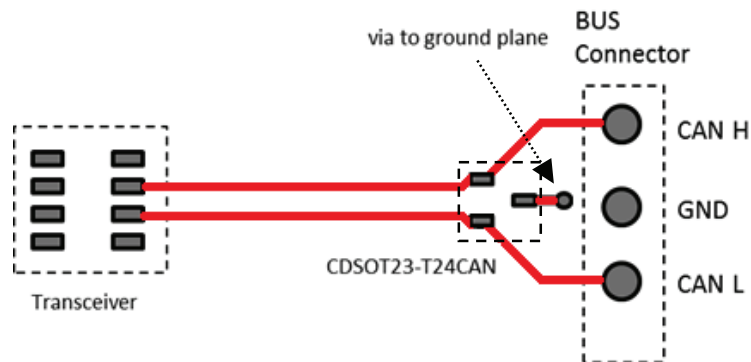

Typical Part Marking

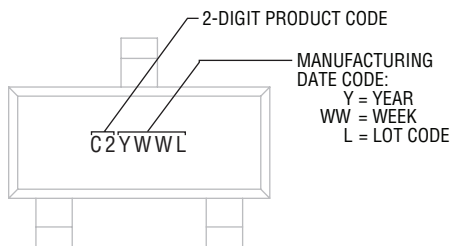

Environmental Specifications

Moisture Sensitivity Level.....	1
ESD Classification (HBM).....	3B

Specifications are subject to change without notice.

The device characteristics and parameters in this data sheet can and do vary in different applications and actual device performance may vary over time. Users should verify actual device performance in their specific applications.

CDSOT23-T24CAN CANbus Protector

BOURNS®

Product Dimensions

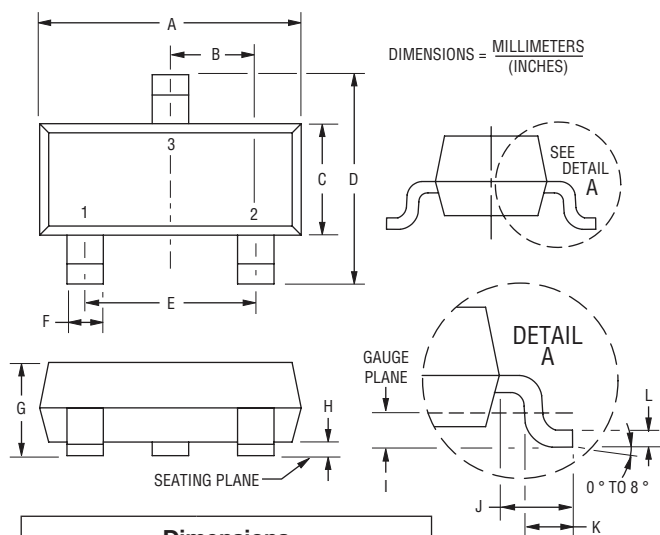

Dimensions

A	$\frac{2.80 - 3.00}{(0.110 - 0.118)}$
B	$\frac{0.95}{(0.037)}$ BSC
C	$\frac{1.20 - 1.40}{(0.047 - 0.055)}$
D	$\frac{2.10 - 2.49}{(0.083 - 0.098)}$
E	$\frac{1.90}{(0.075)}$ BSC
F	$\frac{0.30 - 0.50}{(0.012 - 0.019)}$
G	$\frac{0.89 - 1.17}{(0.035 - 0.046)}$
H	$\frac{0.05 - 0.15}{(0.002 - 0.006)}$
I	$\frac{0.25}{(0.010)}$ BSC
J	$\frac{0.46 - 0.64}{(0.018 - 0.025)}$
K	$\frac{0.40 - 0.58}{(0.016 - 0.023)}$
L	$\frac{0.08 - 0.20}{(0.003 - 0.008)}$

Recommended Footprint

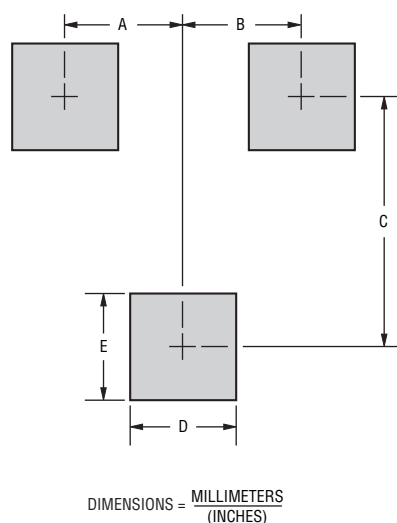

Dimensions

A	$\frac{0.95}{(0.037)}$
B	$\frac{0.95}{(0.037)}$
C	$\frac{2.00}{(0.079)}$
D	$\frac{0.85}{(0.033)}$
E	$\frac{0.85}{(0.033)}$

How to Order

CD SOT23 - T 24 CAN

Common Code _____

Chip Diode _____

Package _____

SOT23 = SOT-23-3L Package _____

Model _____

T = Transient Voltage Suppressor _____

Working Reverse Voltage _____

24 = 24 V _____

Suffix _____

CAN = CANbus Protector _____

Specifications are subject to change without notice.

The device characteristics and parameters in this data sheet can and do vary in different applications and actual device performance may vary over time. Users should verify actual device performance in their specific applications.

CDSOT23-T24CAN CANbus Protector

BOURNS®

Packaging Information

The product is dispensed in tape and reel format (see diagram below).

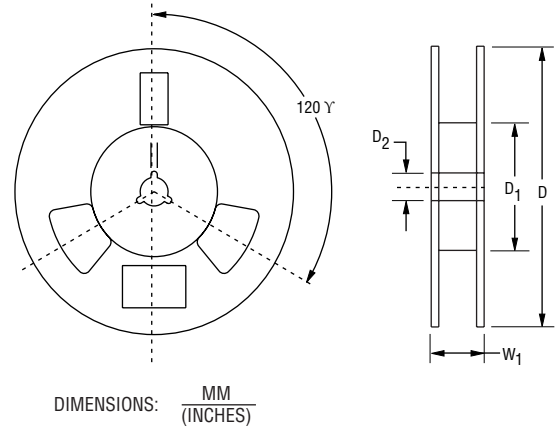
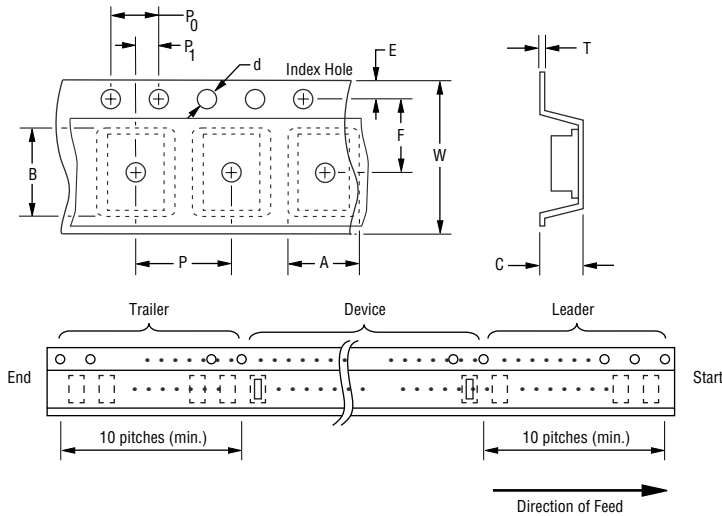

Devices are packed in accordance with EIA standard RS-481-A.

Item	Symbol	SOT-23
Carrier Width	A	$\frac{2.25 \pm 0.10}{(0.088 - 0.004)}$
Carrier Length	B	$\frac{2.34 \pm 0.10}{(0.092 - 0.004)}$
Carrier Depth	C	$\frac{1.22 \pm 0.10}{(0.048 - 0.004)}$
Sprocket Hole	d	$\frac{1.55 \pm 0.05}{(0.061 - 0.002)}$
Reel Outside Diameter	D	$\frac{178}{(7.008)}$
Reel Inner Diameter	D ₁	$\frac{50.0}{(1.969)}$ Min.
Feed Hole Diameter	D ₂	$\frac{13.0 \pm 0.20}{(0.512 \pm 0.008)}$
Sprocket Hole Position	E	$\frac{1.75 \pm 0.10}{(0.069 \pm 0.004)}$
Punch Hole Position	F	$\frac{3.50 \pm 0.05}{(0.138 \pm 0.002)}$
Punch Hole Pitch	P	$\frac{4.00 \pm 0.10}{(0.157 - 0.004)}$
Sprocket Hole Pitch	P ₀	$\frac{4.00 \pm 0.10}{(0.157 \pm 0.004)}$
Embossment Center	P ₁	$\frac{2.00 \pm 0.05}{(0.079 \pm 0.002)}$
Overall Tape Thickness	T	$\frac{0.20 \pm 0.10}{(0.008 \pm 0.004)}$
Tape Width	W	$\frac{8.00 \pm 0.20}{(0.315 - 0.008)}$
Reel Width	W ₁	$\frac{14.4}{(0.567)}$ Max.
Quantity per Reel	--	3,000

REV. 01/18

Specifications are subject to change without notice. The device characteristics and parameters in this data sheet can and do vary in different applications and actual device performance may vary over time. Users should verify actual device performance in their specific applications.

Mouser Electronics

Authorized Distributor

Click to View Pricing, Inventory, Delivery & Lifecycle Information:

Bourns:

[CDSOT23-T24CAN](#) [CDSOT23-T24CAN-Q](#)